

REVISIONS				
REV.	ECO. NO	DESCRIPTION	DATE	BY
J	3456	ADD 04 POSITION, UPDATE P/N IN TITLE BLOCK, UPDATE MATERIAL SECTION IN P/N CODING, UPDATE DWG FORMAT	5/26/2016	MG
K	4133	UPDATE NOTE 8 (WAS 3A), ADD POSI 7, ADD 'D' & 'E' DIM FOR POSI 2,3,4, ADD PCB LAYOUT	10/23/2019	JH

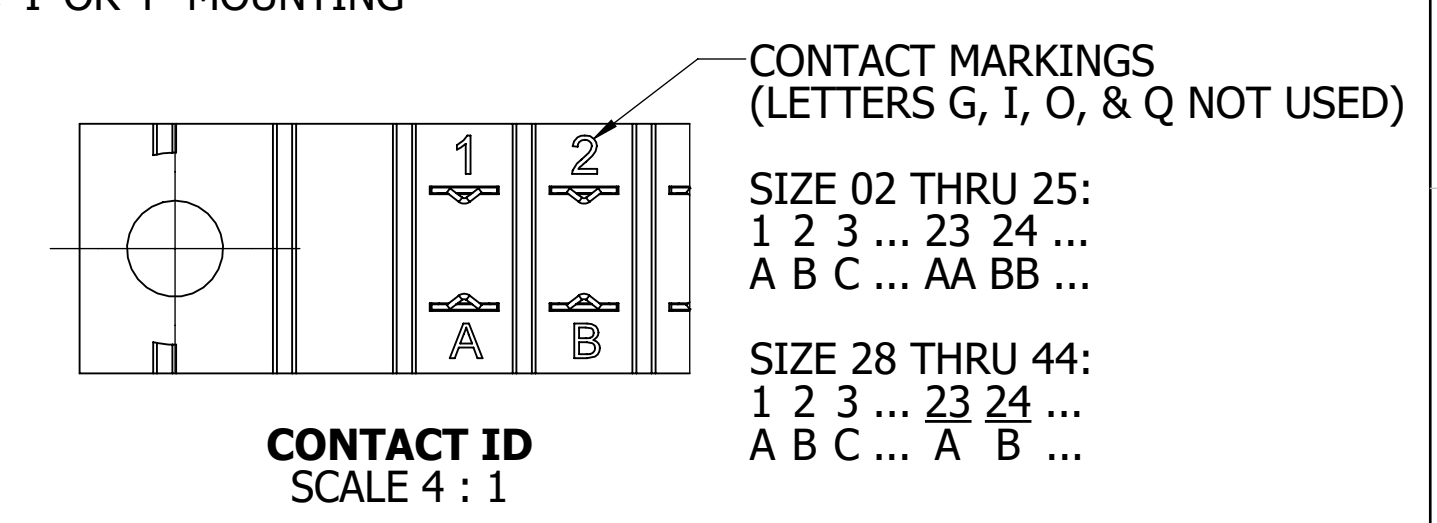

- NOTES:**
1. INSULATOR MATERIAL: SEE PART NUMBER CODING
 2. CONTACT MATERIAL: SEE PART NUMBER CODING
 3. PLATING: SEE PART NUMBER CODING
 4. OPERATING TEMPERATURE: SEE PART NUMBER CODING
 5. PROCESSING TEMP: SEE PART NUMBER CODING
 6. UL FLAMMABILITY RATING: 94V-0
 7. OPERATING VOLTAGE: 950 VAC
 8. CURRENT RATING: 5 AMP
 9. CONTACT RESISTANCE: 30 MILLI OHMS MAX
 10. INSULATION RESISTANCE: 5000 MEGA OHMS
 11. DURABILITY: 500 CYCLES MINIMUM
 12. CONNECTOR IDENTIFICATION: THE PART SHALL BE MARKED WITH A PART NUMBER AND LOT CODE
 13. BOARD THICKNESS ACCOMMODATED: .062 ± .008 [1.57 ± 0.20]
 14. INSERTION FORCE: 16 OZ MAX PER CONTACT PAIR WHEN USING A .062 [1.57] TEST BLADE
INTERNAL INSPECTION TO BE PER SULLINS WORK INSTRUCTION WI-8.6-03
 15. WITHDRAWAL FORCE: 1 OZ MIN PER CONTACT PAIR USING .062 [1.57] TEST BLADE
 16. MODIFICATION: SEE PART NUMBER CODING

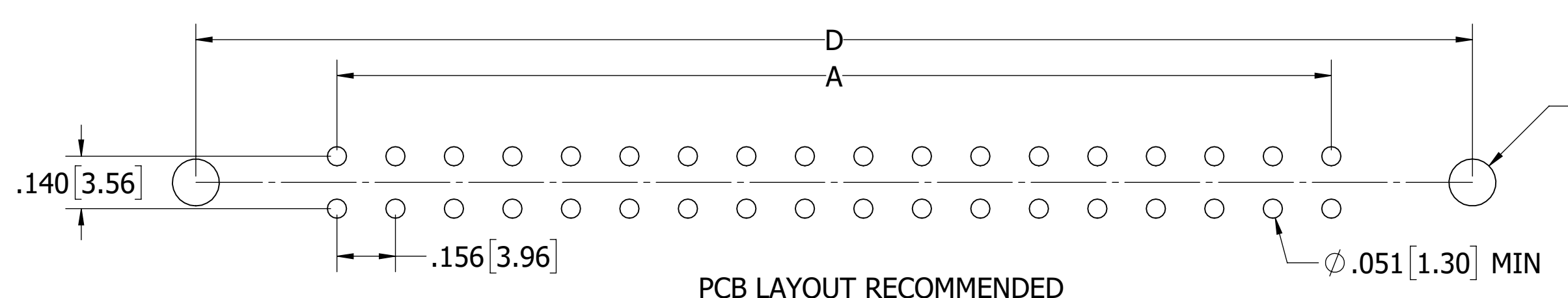
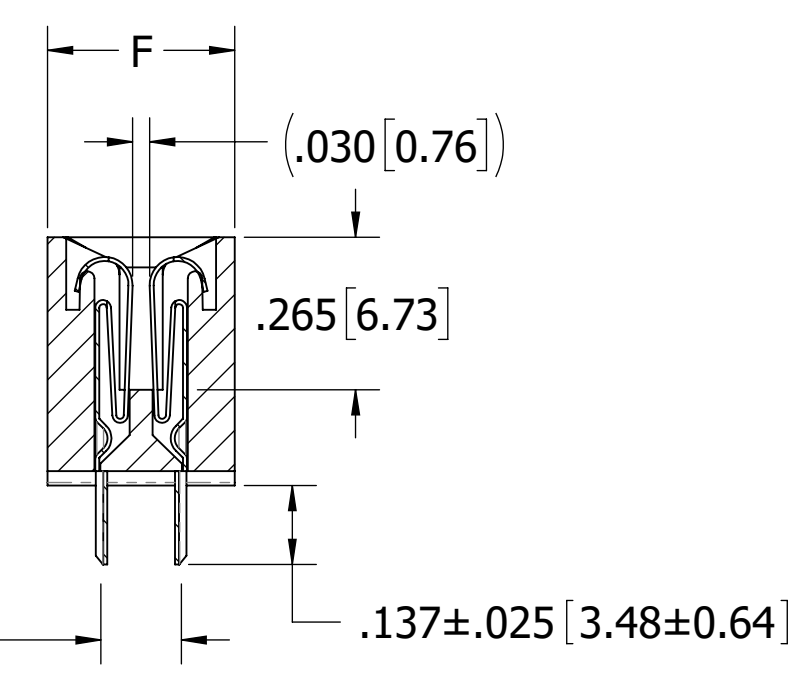
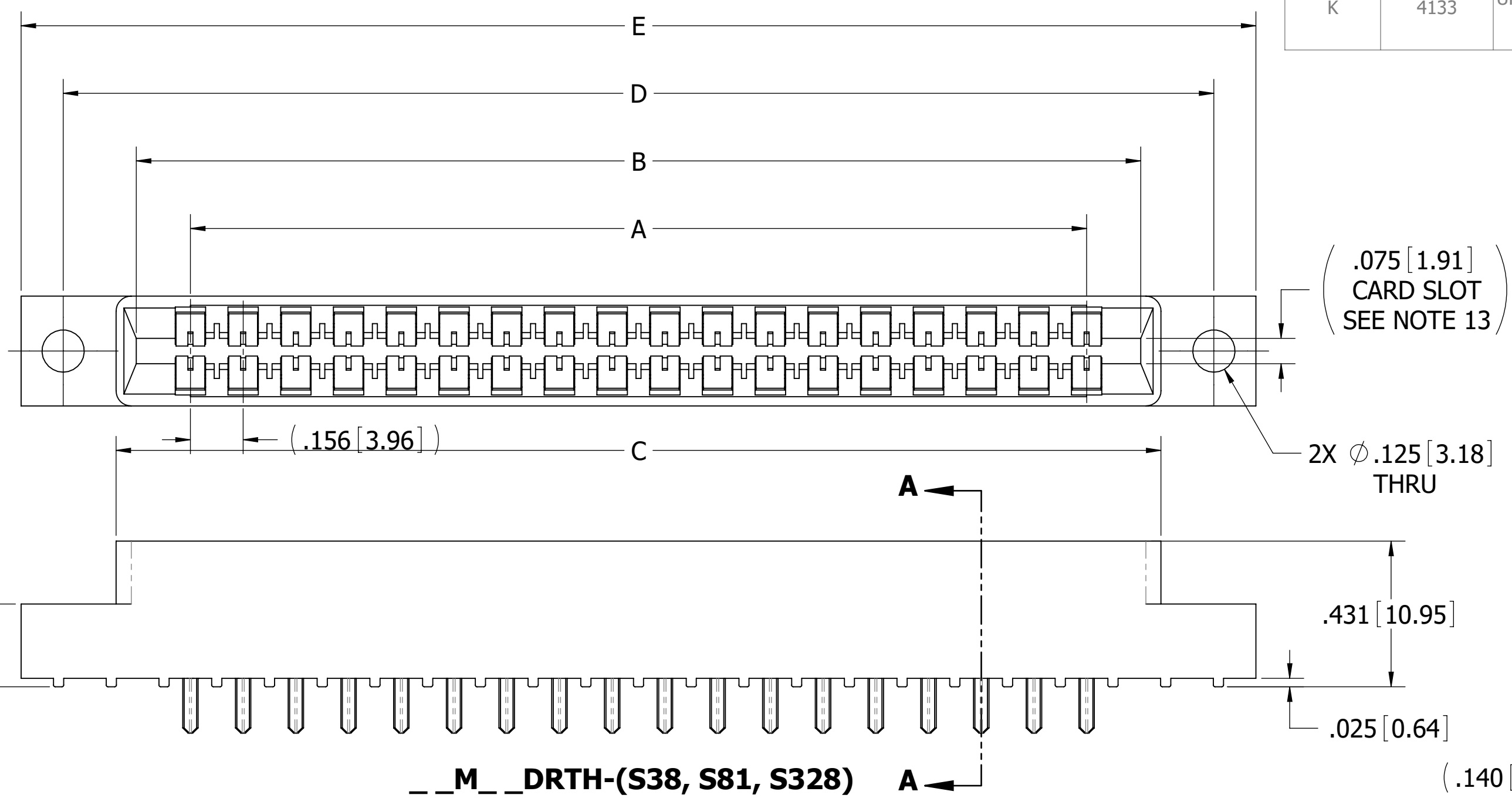

CUSTOMER COPY

UNLESS OTHERWISE SPECIFIED: DIMENSIONS ARE IN INCHES [MM]		DRAWN	DATE	NAME	
			3/7/2008	MNH	
TOLERANCES: ANGULAR: ± 1° DECIMALS .XX = ± .02 [.5] .XXX = ± .005 [.13] .XXXX = ± .0005 [.013]					<small>THE INFORMATION HEREIN CONTAINS PROPRIETARY INFORMATION OF SULLINS ELECTRONICS AND IS NOT TO BE REPRODUCED, USED OR DISCLOSED TO OTHERS FOR ANY PURPOSE EXCEPT AS SPECIFICALLY AUTHORIZED IN WRITING BY AN OFFICER OF SULLINS ELECTRONICS.</small>
					TITLE EDGE CARD, .156 CC, LP
					PART NUMBER _M_DRT_(OMIT,-S38,-S81,-S328)
SIZE	CAGE CODE	DWG. NO.	REV		
C	54453	C11077	K		
SCALE: 3:1		SHEET 1 OF 3			

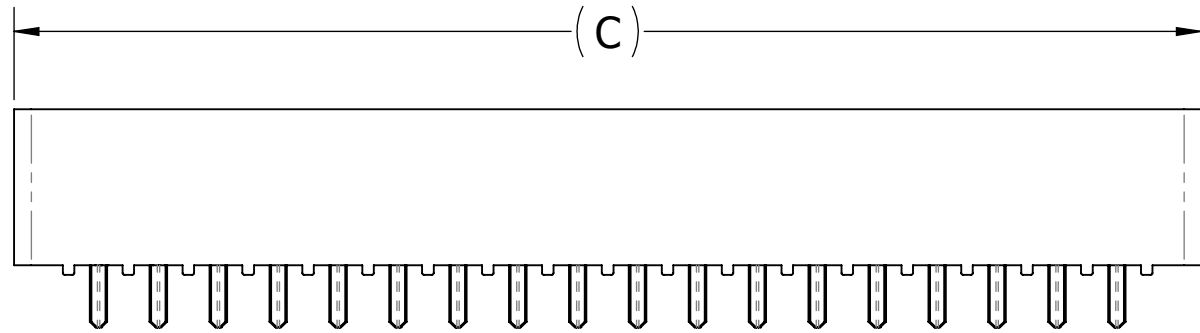
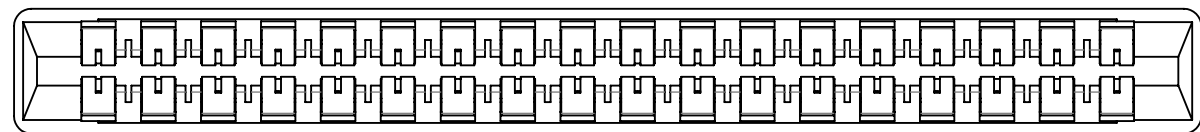

__M__DRTN-(S38, S81, S328)

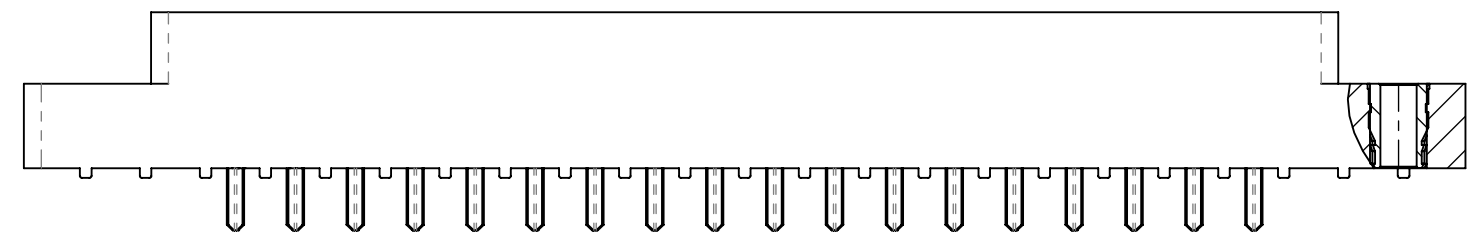
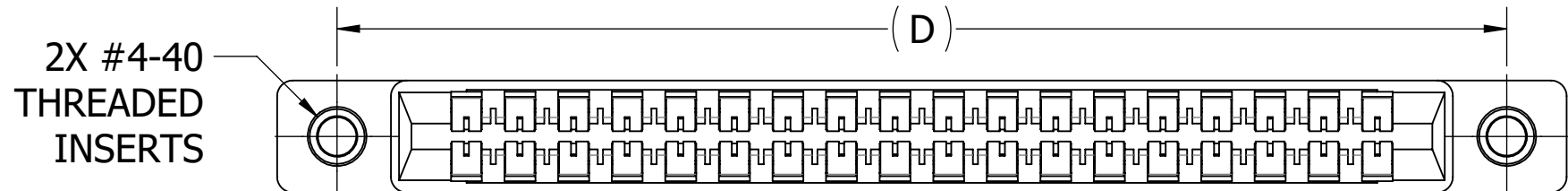

__M__DRTI-(S38, S81, S328)

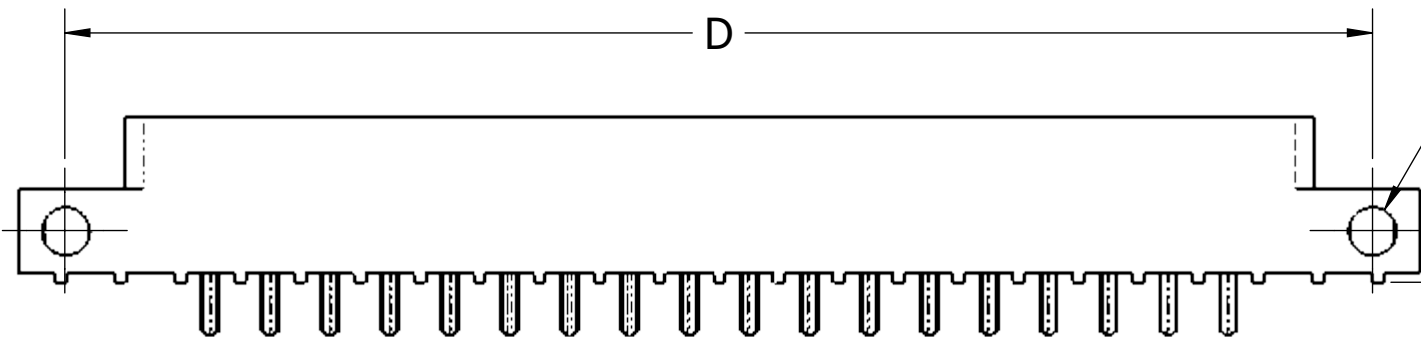
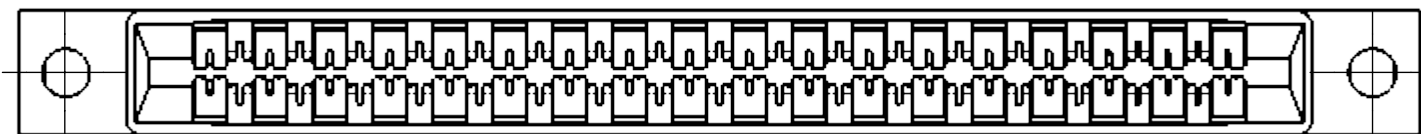

__M__DRTS-(S38, S81, S328)

2X FLOATING BOBBIN
 $\phi .116 [2.95]$ CLEARANCE
 FOR # 4 SCREW

2X $\phi .125 [3.18]$
 THRU

$.135 [3.43]$

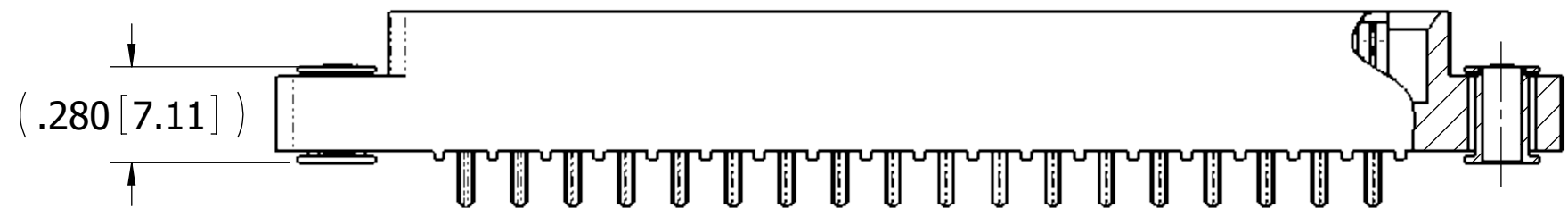
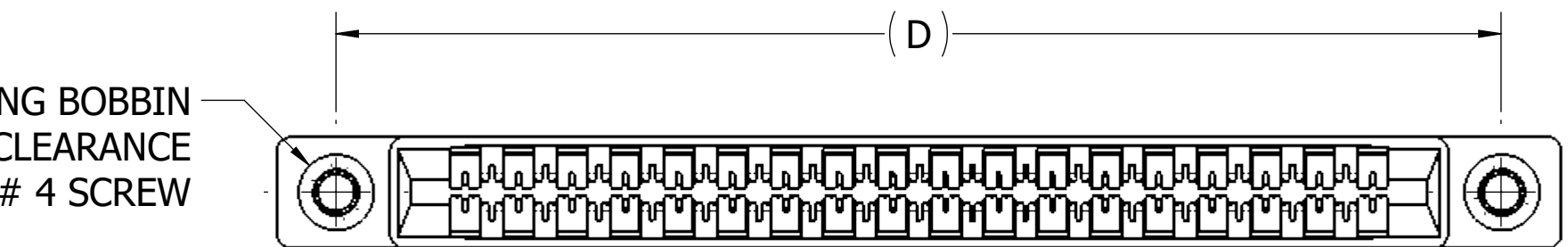

__M__DRTF-(S38, S81, S328)

$(.280 [7.11])$

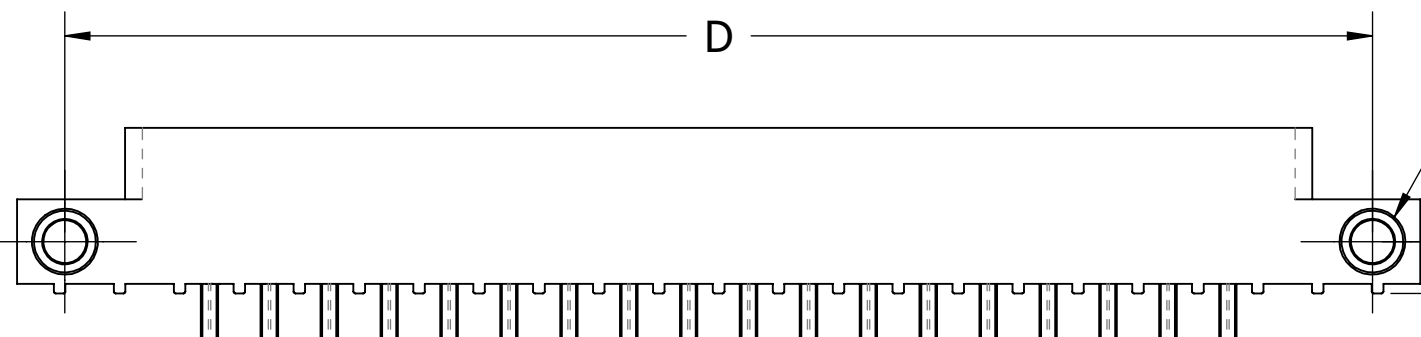
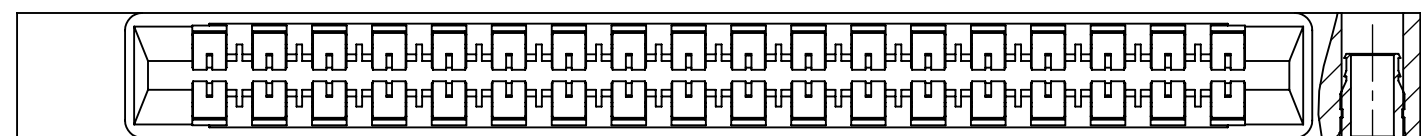

M_DRTA-(S38, S81, S328)
 (CONSULT FACTORY FOR 'A' MOUNTING OPTION)

2X #4-40
 THREADED
 INSERTS

$.135 [3.43]$

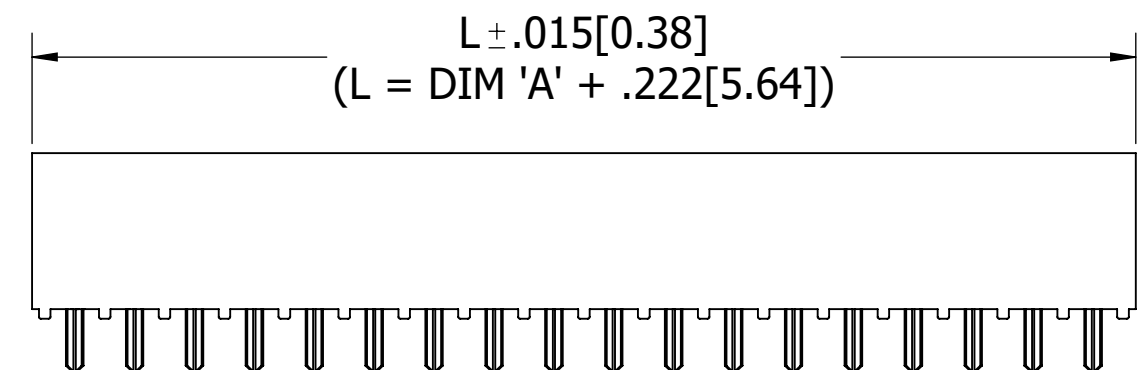
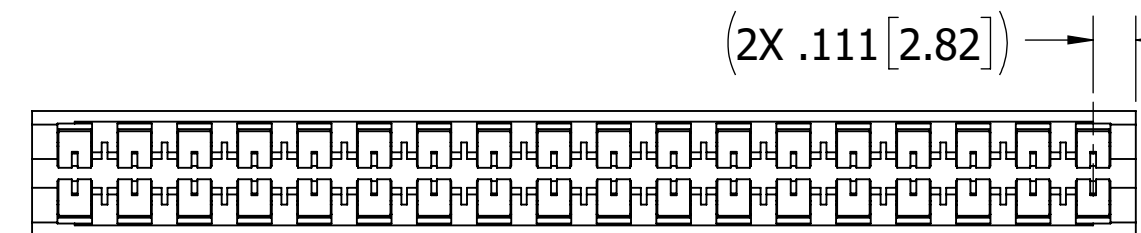

__M__DRTB-(S38, S81, S328)

$(2X .111 [2.82])$

$L \pm .015 [0.38]$
 $(L = \text{DIM 'A'} + .222 [5.64])$

CUSTOMER COPY

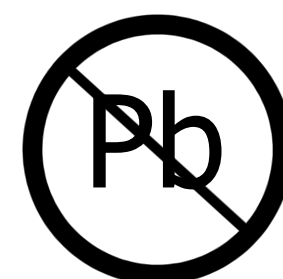

RoHS COMPLIANT

UNLESS OTHERWISE SPECIFIED: DIMENSIONS ARE IN INCHES [MM]		DRAWN	DATE	NAME	
			3/7/2008	MNH	
TOLERANCES: ANGULAR: $\pm 1^\circ$ DECIMALS .XX = $\pm .02 [5]$.XXX = $\pm .005 [13]$.XXXX = $\pm .0005 [13]$					TITLE EDGE CARD, .156 CC, LP
THE INFORMATION HEREIN CONTAINS PROPRIETARY INFORMATION OF SULLINS ELECTRONICS AND IS NOT TO BE REPRODUCED, USED OR DISCLOSED TO OTHERS FOR ANY PURPOSE EXCEPT AS SPECIFICALLY AUTHORIZED IN WRITING BY AN OFFICER OF SULLINS ELECTRONICS.					PART NUMBER __M__DRT__(OMIT,-S38,-S81,-S328)
SIZE	CAGE CODE	DWG. NO.		REV	
C	54453	C11077		K	
SCALE: 2:1		SHEET 2 OF 3			

PART NUMBER	NO. OF POS.	A ± .008[0.20]		B ±.008[0.20]		C ±.015[0.38]		D ±.010[0.25]		E ±.020[0.51]		E ±.020[0.51]		F +.005/-.015[+0.13/-0.38]	
		IN	MM	IN	MM	IN	MM	IN	MM	IN	MM	IN	MM	IN	MM
		M02DRT	2	0.156	3.96	0.476	12.09	0.596	15.14	0.909	23.09	1.158	29.41	1.258	31.95
M03DRT	3	0.312	7.92	0.632	16.05	0.752	19.10	1.065	27.05	1.314	33.38	1.414	35.92		
M04DRT	4	0.468	11.89	0.788	20.02	0.908	23.06	1.221	31.01	1.470	37.34	1.570	39.88		
M06DRT	6	0.780	19.81	1.100	27.94	1.220	30.99	1.533	38.94	1.782	45.26	1.882	47.80		
M07DRT	7	0.936	23.77	1.256	31.90	1.376	34.95	1.689	42.90	1.938	49.23	2.038	51.77		
M08DRT	8	1.092	27.74	1.412	35.86	1.532	38.91	1.845	46.86	2.094	53.19	2.194	55.73		
M10DRT	10	1.404	35.66	1.724	43.79	1.844	46.84	2.157	54.79	2.406	61.11	2.506	63.65		
M11DRT	11	1.560	39.62	1.880	47.75	2.000	50.80	2.313	58.75	2.562	65.07	2.662	67.61		
M12DRT	12	1.716	43.59	2.036	51.71	2.156	54.76	2.469	62.71	2.718	69.04	2.818	71.58		
M15DRT	15	2.184	55.47	2.504	63.60	2.624	66.65	2.937	74.60	3.186	80.92	3.286	83.46		
M18DRT	18	2.652	67.36	2.972	75.49	3.092	78.54	3.405	86.49	3.654	92.81	3.754	95.35		
M22DRT	22	3.276	83.21	3.596	91.34	3.716	94.39	4.029	102.34	4.278	108.66	4.378	111.20		
M24DRT	24	3.588	91.14	3.908	99.26	4.028	102.31	4.341	110.26	4.590	116.59	4.690	119.13		
M25DRT	25	3.744	95.10	4.064	103.23	4.184	106.27	4.497	114.22	4.746	120.55	4.846	123.09		
M28DRT	28	4.212	106.98	4.532	115.11	4.652	118.16	4.965	126.11	5.214	132.44	5.314	134.98		
M36DRT	36	5.460	138.68	5.780	146.81	5.900	149.86	6.213	157.81	6.462	164.13	6.562	166.67		
M43DRT	43	6.552	166.42	6.872	174.55	6.992	177.60	7.305	185.55	7.554	191.87	7.654	194.41		
M44DRT	44	6.708	170.38	7.028	178.51	7.148	181.56	7.461	189.51	7.710	195.83	7.810	198.37		
														0.438	11.13
														0.500	12.70

FOR CONNECTORS WITH THREADED INSERTS OR FLOATS

PART NUMBER CODING

M **DRT** **-S**

MATERIAL (INSULATOR/CONTACT)

- E = BLUE PBT/ PHOSPHOR BRONZE**
OPERATING TEMP: -65°C TO +125°C
PROCESSING TEMP: WAVE/MANUAL SOLDERING ONLY
- R = GREEN PPS/ PHOSPHOR BRONZE**
OPERATING TEMP: -65°C TO +125°C
PROCESSING TEMP: 260°C MAX FOR 20 SECONDS
- G = BLACK PA9T/ PHOSPHOR BRONZE**
OPERATING TEMP: -65°C TO +125°C
PROCESSING TEMP: 260°C MAX FOR 20 SECONDS
- H = BLUE PBT/ BERYLLIUM COPPER**
OPERATING TEMP: -65°C TO +125°C
PROCESSING TEMP: WAVE/MANUAL SOLDERING ONLY
- A = GREEN PPS/ BERYLLIUM COPPER**
OPERATING TEMP: -65°C TO +150°C
PROCESSING TEMP: 260°C MAX FOR 20 SECONDS
- J = BLACK BLACK PA9T/ BERYLLIUM COPPER**
OPERATING TEMP: -65°C TO +150°C
PROCESSING TEMP: 260°C MAX FOR 20 SECONDS
- F = GREEN PPS/ SPINODAL (CONSULT FACTORY)**
OPERATING TEMP: -65°C TO +200°C
(CONSULT FACTORY FOR SPECIAL SOLDERING GUIDELINES)
AVAILABLE IN OVERALL GOLD ONLY (S OR M PLATING CODE)
- C = GREEN PPS/ BERYLLIUM NICKEL (CONSULT FACTORY)**
OPERATING TEMP: -65°C TO +200°C
PROCESSING TEMP: 260°C MAX FOR 20 SECONDS
AVAILABLE IN OVERALL GOLD ONLY (S OR M PLATING CODE)
- W = TAN PEEK/ BERYLLIUM NICKEL (CONSULT FACTORY)**
OPERATING TEMP: -65°C TO +250°C
PROCESSING TEMP: 260°C MAX FOR 20 SECONDS
AVAILABLE IN OVERALL GOLD ONLY (M PLATING CODE)

MODIFICATION

- OMIT FOR STANDARD, EX: 'EBM22DRTH'
- S38 = BLACK PBT (MATERIAL CODE E AND H ONLY)
- S81 = GREEN PBT (MATERIAL CODE E AND H ONLY)
- S328 = BROWN PPS (MATERIAL CODE R AND A ONLY)

MOUNTING STYLE

- H = .125" DIA. CLEARANCE HOLES
- N = NO MOUNTING EARS
- S = .125" DIA. SIDE MOUNTING
- I = #4-40 THREADED INSERT
- F = FLOATING BOBBIN
- B = OPEN CARD SLOT
- *A = #4-40 THREADED INSERT SIDE MOUNTING
(*CONSULT FACTORY FOR 'A' MOUNTING OPTION)

NUMBER OF POSITIONS

(CONTACTS PER ROW)

PLATING

ALL PLATINGS ARE LEAD FREE AND HAVE .000050" NICKEL UNDERPLATE

CONTACT SURFACE	TERMINATION
B = .000010" GOLD	.000100" PURE TIN, MATTE
C = .000030" GOLD	.000100" PURE TIN, MATTE
G = .000010" GOLD	.000005" GOLD
Y = .000030" GOLD	.000005" GOLD
**E = .000100" PURE TIN, MATTE, OVERALL	
S = .000010" GOLD OVERALL	
M = .000030" GOLD	.000010" GOLD OVERALL
** OVERALL TIN ONLY AVAILABLE ON MATERIAL CODES E, R AND S	

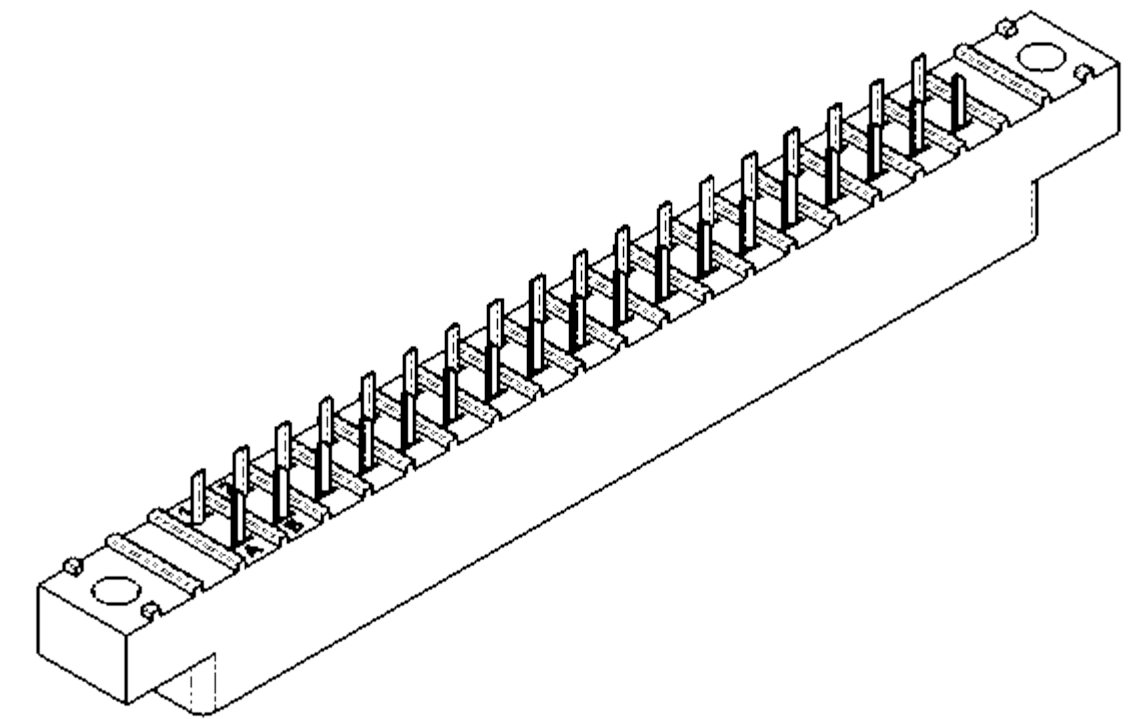

CUSTOMER COPY

UNLESS OTHERWISE SPECIFIED: DIMENSIONS ARE IN INCHES [MM]	DRAWN	DATE	NAME	
		3/7/2008	MNH	
TOLERANCES:				<small>THE INFORMATION HEREIN CONTAINS PROPRIETARY INFORMATION OF SULLINS ELECTRONICS AND IS NOT TO BE REPRODUCED, USED OR DISCLOSED TO OTHERS FOR ANY PURPOSE EXCEPT AS SPECIFICALLY AUTHORIZED IN WRITING BY AN OFFICER OF SULLINS ELECTRONICS.</small>
ANGULAR: ± 1°				
DECIMALS				
.XX=± .02 [.5] .XXX=± .005 [.13] .XXXX=± .0005 [.013]				
TITLE		EDGE CARD, .156 CC, LP		
PART NUMBER		M_DRT_(OMIT,-S38,-S81,-S328)		
SIZE	CAGE CODE	DWG. NO.	REV	
C	54453	C11077	K	
SCALE: 3:1		SHEET 3 OF 3		